

FONT POST

E9B278- -

base number Color Finish
 Temperature Options

- To build a product code in our configurator select the specify button on the base model # product page
- To build a manual product code on this datasheet choose from the options listed below in blue font and add the suffix to the base model #

GENERAL

Series: Font
 Brand: Platek
 Division: Exterior
 Mounting Type: Post
 Mounting Location: Above Ground
 Subcategory: Bollard

PHYSICAL

Shape: Drum
 Diameter (mm): 204
 Diameter (in): 8 1/8
 Height (mm): 500
 Height (in): 19 11/16
 Light Distribution: Direct
 Screws: A4 stainless steel
 Diffuser: Extra Clear Flat Tempered Glass - 12mm / 1/2" thick
 Fixture Finish: [BLK](#) / [WHI](#) / [GRY](#) / [COR](#) / [ANT](#) / [BRZ](#)
 Fixture Material: Metal

ELECTRICAL

Lamp Type: LED
 Input Wattage (W): 13.5
 Total Output Wattage (W): 11.7
 Dimming: Tri-Mode (Non-Dimming and Phase Dimming (120Vac only) and 0-10V Dimming)
 Driver Included: Yes
 Driver Location: Integrated
 Driver Type: Constant Current - Universal
 Driver Class: Class 2
 Input Voltage (V): 120 - 277
 Constant Current (MA): 350

LED

Number of LEDs: 4
 Color Temperature (°K): [2700](#) / [3000](#) / [4000](#)
 Max. Delivered Lumen (lm): 1055 / 1055 / 1110
 Nominal Lumen (lm): 1680 / 1680 / 1740
 CRI: >80 CRI
 Lamp Life (hrs): 60000

OPTICAL

Optic: Diffused
 Beam Angle: 360

RATINGS AND CERTIFICATIONS

Certified By: Certified for North American Standards
 IP rating: IP65
 IK Rating: IK08

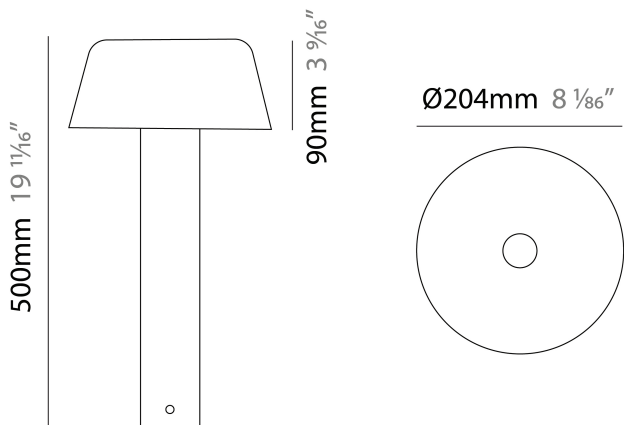

FONT POST

E9B278-

PROJECT

TYPE

SPECIFIER

QUANTITY

DATE



PROJECT _____
 TYPE _____
 SPECIFIER _____
 QUANTITY _____
 DATE _____

FONT POST

E9B280-

base number _____
 Color _____
 Temperature _____
 Finish _____
 Options _____

- To build a product code in our configurator select the specify button on the base model # product page
- To build a manual product code on this datasheet choose from the options listed below in blue font and add the suffix to the base model #

GENERAL

Series: Font _____
 Brand: Platek _____
 Division: Exterior _____
 Mounting Type: Post _____
 Mounting Location: Above Ground _____
 Subcategory: Bollard _____

PHYSICAL

Shape: Drum _____
 Diameter (mm): 204 _____
 Diameter (in): 8 1/16 _____
 Height (mm): 500 _____
 Height (in): 19 11/16 _____
 Light Distribution: Direct _____
 Screws: A4 stainless steel _____
 Diffuser: Extra Clear Flat Tempered Glass - 12mm / 1/2" thick _____
 Fixture Finish: [BLK](#) / [WHI](#) / [GRY](#) / [COR](#) / [ANT](#) / [BRZ](#) _____
 Fixture Material: Metal _____

ELECTRICAL

Lamp Type: LED _____
 Input Wattage (W): 13.5 _____
 Total Output Wattage (W): 11.7 _____
 Dimming: Tri-Mode (Non-Dimming and Phase Dimming (120Vac only) and 0-10V Dimming) _____
 Driver Included: Yes _____
 Driver Location: Integrated _____
 Driver Type: Constant Current - Universal _____
 Driver Class: Class 2 _____
 Input Voltage (V): 120 - 277 _____
 Constant Current (MA): 350 _____

LED

Number of LEDs: 4 _____
 Color Temperature (°K): [2700](#) / [3000](#) / [4000](#) _____
 Max. Delivered Lumen (lm): 1055 / 1055 / 1110 _____
 Nominal Lumen (lm): 1680 / 1680 / 1740 _____
 CRI: >80 CRI _____
 Lamp Life (hrs): 60000 _____

OPTICAL

Optic^o: Diffused _____
 Beam Angle: 360 _____

RATINGS AND CERTIFICATIONS

Certified By: Certified for North American Standards _____
 IP rating: IP65 _____
 IK Rating: IK08 _____

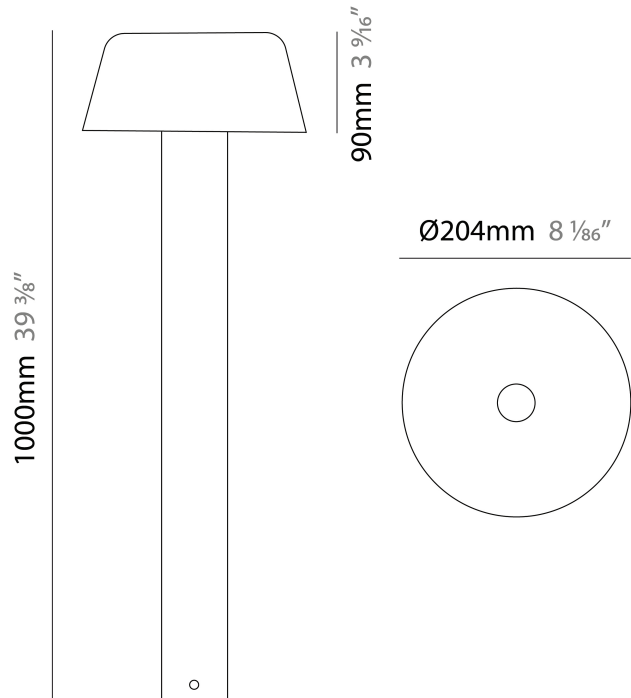

FONT POST

E9B280-

PROJECT _____

TYPE _____

SPECIFIER _____

QUANTITY _____

DATE _____

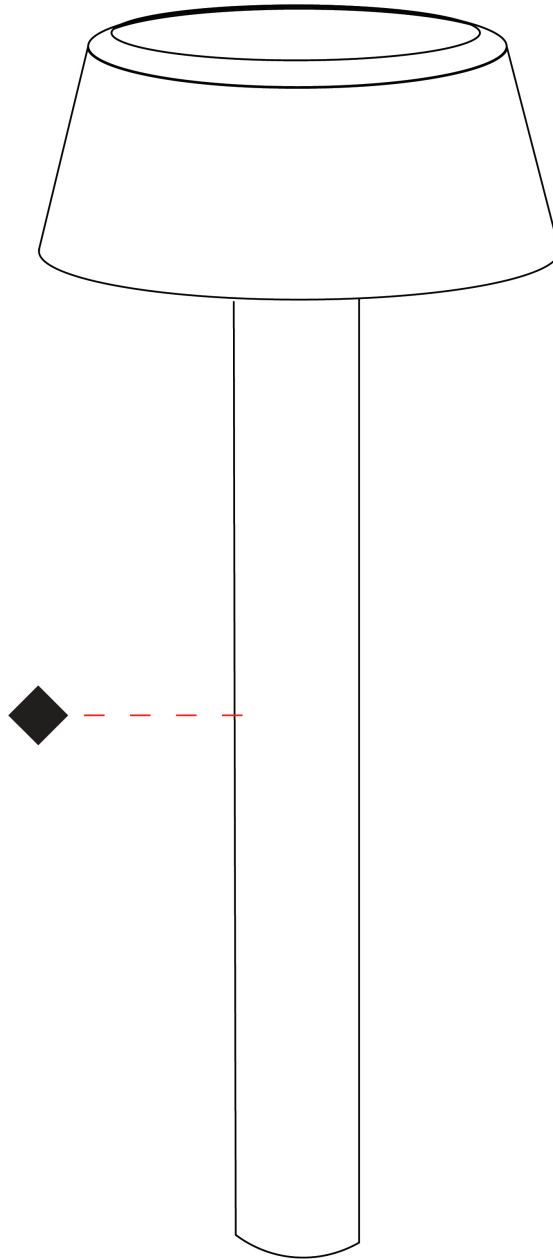

E

PROJECT	_____
TYPE	_____
SPECIFIER	_____
QUANTITY	_____
DATE	_____

Fixture Finish

Black - BLK



White - WHI



Gray - GRY



Corten - COR



Anthracite - ANT



Bronze - BRZ



Digital: Not all screens are calibrated the same, and therefore, colors will appear differently between screens.

Physical: When texture is involved, there will be variations in color, character and tone within a product series and between product families.













PROJECT	
TYPE	
SPECIFIER	
QUANTITY	
DATE	











LEGEND

 floor-mounted	 pivotable	 special LED (upon request) RGB, RGBW, tunable, gold+, meat+, art+, fashion+
 wall and ceiling: recessed and surface mounted	 rotating	 warm dim / natural dimming LED
 ceiling-mounted and wall-mounted	 illuminate tilted	 rechargeable battery powered
 wall-mounted	 color of suspension cable	 fixture with natural vivid LED (upon request)
 omni-directional light distribution	 length of suspension cable	 color rendering index
 direct light distribution	 reflector degree selection	 color temperature
 direct/indirect light distribution	 super spot	 lumen (luminous flux)
 indirect light distribution	 lens	 efficacy (lumens per watt)
 asymmetric light distribution	 lens pack	 Unified Glare Rating (UGR) range from 5-40
 aura light distribution	 shine ring	 marine grade (AISI 316 stainless steel)
 round wall or ceiling cut-out	 integrated shine ring with diffuser	 walk on
 square wall or ceiling cut-out	 free individual colors 01-29	 drive on
 the supplied jig specifies the cutout dimensions	 individual colors: 00 (free of charge), 01-25 (extra charge)	 Dark Sky Compliance
 minimum distance (meters) lamp - object	 luminaire part to be colored (F1)	 Americans with Disabilities Act (less than 4" off the wall located between 27"-84" from floor)
 recessed depth	 luminaire part to be colored (F2)	 lamp protected against explosion
 ceiling thickness in mm	 luminaire part to be colored (F3)	 blown glass using traditional methods by master glass blower
 ceiling thickness selection	 luminaire part to be colored (F4)	 acoustic material
 dimmable DP (phase), DV (0-10V), DD (dali), DS (step-dim)	 luminaire part to be colored (F5)	 protection class I, protection insulation
 included or excluded LED driver/transformer/control gear	 color of 3-circuit adaptor	 protection class II, protection insulation
 separately switchable	 indirect diffuser	 ETL Certified to UL and CSA Standards
 sensor	 direct diffuser	 UL Certified to UL and CSA Standards
 remote control	 ball-proof (upon request)	 CSA Certified to UL and CSA Standards
 available upon request	 accessory	 Certified for North American Standards

IP RATING

 IP20	protected against ingress of solid bodies greater than 12.5mm (finger)
 IP33	protected against ingress of solid bodies greater than 2.5mm protected against sprays of water up to 60 degrees from the vertical (rain)
 IP40	protected against ingress of solid bodies greater than 1mm (wire) no protection against the ingress of moisture
 IP43	protected against ingress of solid bodies greater than 1mm (wire) protected against sprays of water up to 60 degrees from the vertical (rain)
 IP44	protected against ingress of solid bodies greater than 1mm (wire) protected against water splashed from all directions
 IP54	protected against limited ingress of dust (wet rooms/covered outdoor areas) protected against water splashed from all directions
 IP65	protected against ingress of dust protected against jets of water
 IP66	protected against ingress of dust protected against powerful jets of water or heavy seas
 IP67	protected against ingress of dust protected against immersion of water between 15cm - 1m for 30 minutes
 IP68	protected against ingress of dust protected against immersion of water under pressure for long periods

IK RATING

 IK01	protected against 0.14 joules impact (equivalent to 0.25kg mass dropped from 56mm above the surface)
 IK02	protected against 0.2 joules impact (equivalent to 0.25kg mass dropped from 80mm above the surface)
 IK03	protected against 0.35 joules impact (equivalent to 0.25kg mass dropped from 140mm above the surface)
 IK04	protected against 0.5 joules impact (equivalent to 0.25kg mass dropped from 200mm above the surface)
 IK05	protected against 0.7 joules impact (equivalent to 0.25kg mass dropped from 280mm above the surface)
 IK06	protected against 1 joules impact (equivalent to 0.25kg mass dropped from 400mm above the surface)
 IK07	protected against 2 joules impact (equivalent to 0.5kg mass dropped from 400mm above the surface)
 IK08	protected against 5 joules impact (equivalent to 1.7kg mass dropped from 300mm above the surface)
 IK09	protected against 10 joules impact (equivalent to 5.0kg mass dropped from 200mm above the surface)
 IK10	protected against 20 joules impact (equivalent to 5.0kg mass dropped from 400mm above the surface)